

desks

Ultra

NEW

Ultra is a new approach offered by MityBilt to meet the demands of today's competitive workplace. Effective as a single desk with a range of options to make it a game changer. The desk boasts a full complement of vertical and horizontal wire management.



UL3060R36 shown with optional return. Table top shown in maple laminate and 3mm edge. Frame shown in silver powder coat finish.

Specifications

Table Top

- 1" Industrial Grade Particleboard Core (45lbs foot density)
- High Pressure (HPL) scratch resistant laminate for longevity with balancing backer sheet.
- 3mm vinyl bonded edge

Table Frame

- Deep Drawn base with floor leveler
- Aesthetic cover to leg component
- Modular construction
- A larger upright allows to accommodate a fixed beam to give greater stability to the structure.
- Integral wire management
- Adjustable floor glides

Colours & Finishes

- Durable powdercoat finish from MityBilt colour selection
- High Pressure Laminate and 3mm vinyl bonded edge from MityBilt colour selection

Options

- Modesty panel
- CPU Holder

Ultra / Desk



Ultra / Return



Desk

Part #	Size (in.)	Leg Style
UL2448	24 x 48	Center
UL2460	24 x 60	Center
UL2472	24 x 72	Center
UL3048	30 x 48	Offset
UL3060	30 x 60	Offset
UL3072	30 x 72	Offset

Return (optional)

Part #	Size (in.)	Leg Style
R36	24 x 36	Center
R48	24 x 48	Center



Ultra Plus

NEW

Ultra Plus allows for the creation of a continual work surface which is popular in office and IT environments. Each table frame gangs to a common supporting leg, creating extra work area without cluttering floor space and jeopardizing leg room with unnecessary supports.



Ultra Plus / Desk

Ultra Plus / Return



Desk

Part #	Size (in.)
UPE2448	24 x 48
UPE2460	24 x 60
UPE2472	24 x 72
UPE3048	30 x 48

Return

Part #	Size (in.)
P36	24 x 36

Integral Wire Management System

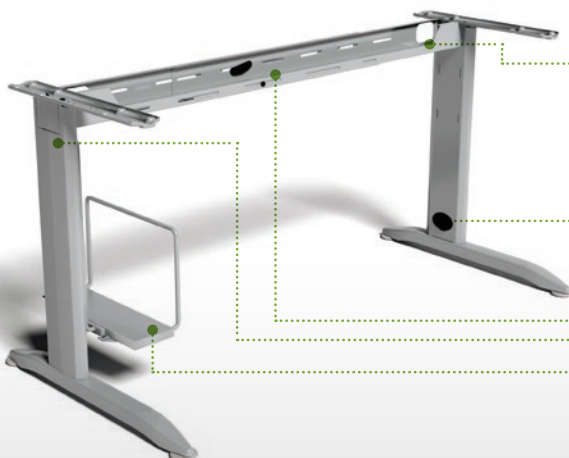

Cut away front wire management channel allows for quick easy access of wires with table top on.

Leg mounted grommets allow for hiding of wires inside the desk leg keeping your office smart and tidy.

Structural wire management channel keeps wires and power bars organized and out of site.

Knock out plates allow for continual flow of wires between tables when in a ganged configuration.

Optional CPU holder fixes next to grommet for ultimate wire management.

Colour Swatches

High Pressure Laminates

Many more options available upon request. Please contact MityBilt for larger samples.

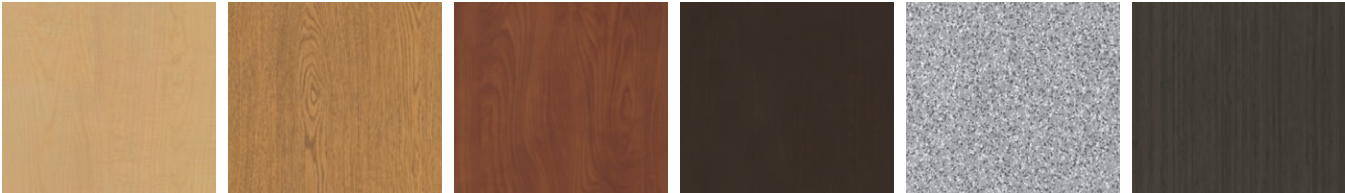

Fusion Maple

Bannister Oak

Wild Cherry

Cafelle

Grey Nebula

Asian Night

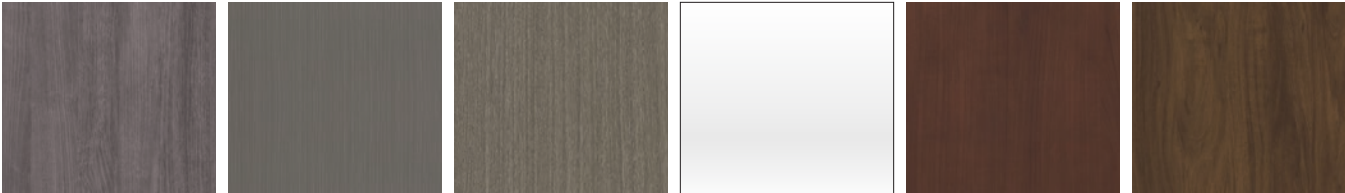

Sterling Ash

Cosmic Strandz

Boardwalk Oak

Designer White

Persian Cherry

Mangalore Mango



Pinnacle Walnut

Studio Teak

Buka Bark

Palisades Oak

Natural Recon

Mission Maple

Colour Swatches

3mm Bonded Edges

Many more options available upon request. Please contact MityBilt for larger samples.



Fusion Maple



Bannister Oak

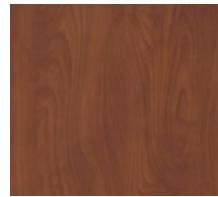

Wild Cherry

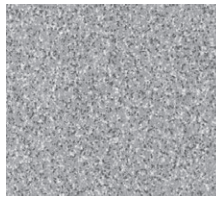

Grey Nebula



Designer White

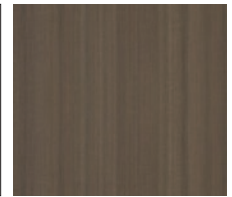

Studio Teak



Silver

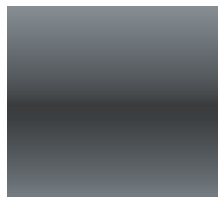

Charcoal



Black

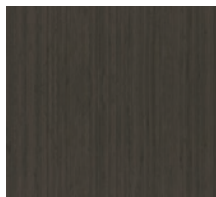

Asian Night

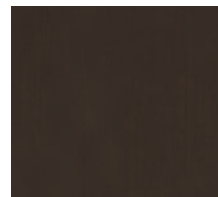

Cafelle

Powder-Coat Options

Many more options available upon request. Please contact MityBilt for larger samples.



Silver



Charcoal

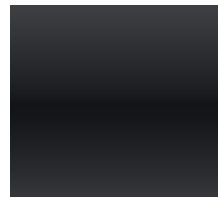

Black

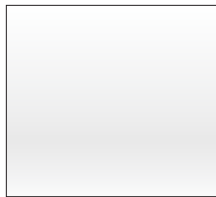

White



Ivory



Gold Vein

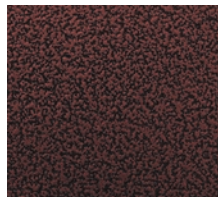

Copper Vein



Silver Vein