

# office

2015 / 2016 Products

 Made in Canada

---

**MITY** BILT

## About

---

MityBilt is an established business with almost 20 years of experience, and known as a company that is dedicated to both its current and future clients. Our aim is to provide the highest quality customer service exceeding the industry expectations. MityBilt's steady growth over the past years has come with a reputation of a high quality product, a hardworking team and customer satisfaction. We deal in both the Institutional and Office settings; including libraries, colleges, halls, sports facilities and other areas that call for 'hard-working' furniture. Our experienced sales staff will work closely with you ensuring that you receive the most appropriate furniture for your environment. Through our long term relationships with our clients, we have a clear understanding of your expectations and requests.

## Made in Canada

---

We are proudly Canadian owned and operated, and based in Stonewall Manitoba. With the wealth and quality of resources available in Canada, it has enabled us to manufacture products that are made up of entirely Canadian raw materials. As a responsible manufacturer we take great care in designing and developing products that will work well for you, and not only look great but work and function with you in mind. Our extensive in-house capability allows us to quickly adapt to the ever changing demands of the market while reducing your lead times and maintaining full quality control.

## Environment

---

GreenGuard Gold



Using material from eco-sustainable sources, including a guaranteed recycled content, green guard laminates, low formaldehyde emission core materials, water based adhesives and paint finishes containing no Volatile Organic Compounds (VOCs), all reduce the Carbon Footprint of our products. Unavoidable manufacturing waste is recycled wherever possible. Effective care for the environment involves working with others; it needs everyone to aim for the same goal. We want to work with you and your clients to provide responsible solutions for their furniture needs, and to minimize the impact on the environment.

## Warranty

---

MityBilt has built a reputation by engineering products that exceed consumer expectations for quality and durability. Our design team is obsessed with making our products even better. We constantly strive to make them truly amazing, and stand behind them once they've left our facility. We are proud to offer a limited lifetime warranty on everything we make. Don't you wish all furniture manufacturers did this?

## Product Testing

---

MityBilt has confidence that every product it manufactures will perform beyond the demands of real world situations. An in-house test facility subjects our tables, chairs and components to extreme forces for hours on end to make certain our products will exceed your expectations. Many tests are carried out on our products during both development and production.

MityBilt uses a third-party accredited test laboratory to perform certain complex testing and to keep up to date with current test requirements and legislation. MityBilt structural table testing exceeds the demands of ANSI-BIFMA and CGSB.



# Contents

## Benching / 6



Kube / 8

Linear / 10

## Desks / 12



Tutor / 13

Icon / 14

Ultra / 16

Pogo2 / 18

Razor / 19

## Tables / 20



Etch / 21

Stride / 22

Neon / 24

Lavo / 25

Vitesse / 26



Quadra Accute / 28

Quadra Twist / 29

Quadra Standard / 29

Espire / 30



Espire Take Off Leg / 32



Espire Folding Leg / 33



Classic / 34

# Contents

## Flip Top / 36



Meso / 37

Neon / 38

Zest / 39

Lavo / 40

Vitesse / 41

## Pedestals / 42



Solo / 43

Café-x / 44

Cosmo-x / 45

Bistro / 46

Tango / 47

## Cafeteria & Side Tables / 48



Side Illusion / 49

Side Flat / 49

Side Quaver / 50

Side Rain / 50

Brunch / 51

## Colour Swatches / 52

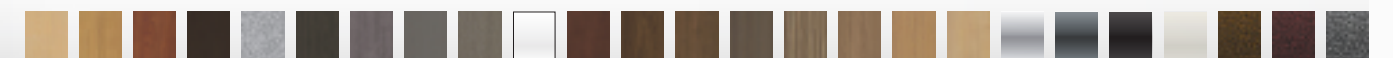

## Case Goods / 54



Suite 300 / 55

Suite 200 / 56

Suite 100 / 58

# benching

## Kube / Linear

Kube and Linear are high specification benching systems that can be arranged to create sophisticated, and exceptionally productive workspaces. The flexible design allows for advanced cable management and technology accommodation.

The robust superstructure of Kube and Linear, together with a clean contemporary design, can be enhanced with the addition of a comprehensive range of optional equipment.



## Kube / Desk



Optional Divider



KUD4860R36 shown in Studio Teak laminate work surface and 3mm edge with Designer White divider panel and white powder coat frame.



### Specifications

#### Table Top

- 1" Industrial Grade Particleboard Core (45lbs foot density)
- High Pressure (HPL) scratch resistant laminate for longevity with balancing backer sheet

#### Colours & Finishes

- Durable powdercoat finish from MityBilt colour selection
- High Pressure Laminate and 3mm vinyl bonded edge from MityBilt colour selection

#### Table Frame

- 30mm x 70mm Tubular End Frame
- Fully welded End Frame
- 30mm x 30mm work surface supporting beams
- Adjustable Floor Glides

#### Options

- Wire Management kit
- Sliding Work Surface
- CPU Holder
- Adjustable Height
- Desk Top Divider

#### Wire Management Kit – Optional

- Pressure fit wire management covers hide wires quickly and easily



#### Sliding Work Surface – Optional

- Sliding work surface makes organizing wires a quick and easy task while keeping them very accessible

## Kube / Components



#### 2 Person

Part #	Size (in.)	Part #	Size (in.)
KUS4848	48 x 48	KUS6448	64 x 48
KUS4860	48 x 60	KUS6460	64 x 60
KUS4872	48 x 72	KUS6472	64 x 72

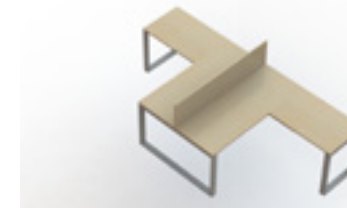

#### + Return

Part #	Size (in.)
R36	24 x 36



#### + Modesty

Part #	Size (in.)
M	to fit desk



#### 4 Person

Part #	Size (in.)	Part #	Size (in.)
KUD4848	48 x 96	KUD6448	64 x 96
KUD4860	48 x 120	KUD6460	64 x 120
KUD4872	48 x 144	KUD6472	64 x 144

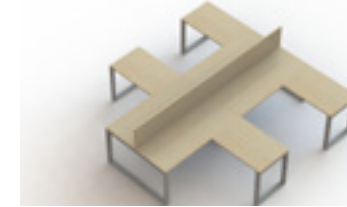

#### + Return

Part #	Size (in.)
R36	24 x 36



#### + Modesty

Part #	Size (in.)
M	to fit desk



#### 6 Person

Part #	Size (in.)	Part #	Size (in.)
KUT4848	48 x 144	KUT6448	64 x 144
KUT4860	48 x 180	KUT6460	64 x 180
KUS4872	48 x 216	KUT6472	64 x 216



#### + Return

Part #	Size (in.)
R36	24 x 36



#### + Modesty

Part #	Size (in.)
M	to fit desk

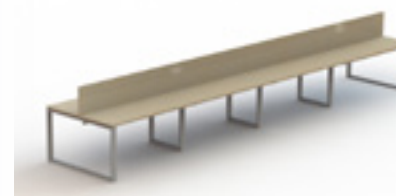

#### 8 Person

Part #	Size (in.)	Part #	Size (in.)
KUQ4848	48 x 192	KUQ6448	64 x 192
KUQ4860	48 x 240	KUQ6460	64 x 240
KUQ4872	48 x 288	KUQ6472	64 x 288



#### + Return

Part #	Size (in.)
R36	24 x 36



#### + Modesty

Part #	Size (in.)
M	to fit desk

## Linear / Desk



Optional Divider

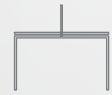

KUD4860R36 shown in Studio Teak laminate work surface and 3mm edge with Designer White divider panel and white powder coat frame.



### Specifications

#### Table Top

- 1" Industrial Grade Particleboard Core (45lbs foot density)
- High Pressure (HPL) scratch resistant laminate for longevity with balancing backer sheet

#### Colours & Finishes

- Durable powdercoat finish from MityBilt colour selection
- High Pressure Laminate and 3mm vinyl bonded edge from MityBilt colour selection

#### Table Frame

- 30mm x 70mm Tubular End Frame
- Fully welded End Frame
- 30mm x 30mm work surface supporting beams
- Adjustable Floor Glides

#### Options

- Wire Management kit
- Sliding Work Surface
- Divider Panel
- Adjustable Height
- CPU holder

#### Wire Management Kit – Optional

- Pressure fit wire management covers hide wires quickly and easily



#### Sliding Work Surface – Optional

- Sliding work surface makes organizing wires a quick and easy task while keeping them very accessible

## Linear / Components



#### 2 Person

Part #	Size (in.)	Part #	Size (in.)
LNS4848	48 x 48	LNS6448	64 x 48
LNS4860	48 x 60	LNS6460	64 x 60
LNS4872	48 x 72	LNS6472	64 x 72

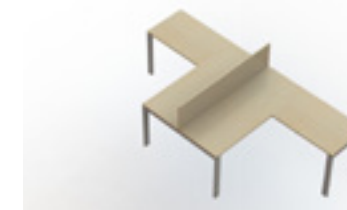

#### + Return

Part #	Size (in.)
R36	24 x 36



#### + Modesty

Part #	Size (in.)
M	to fit desk



#### 4 Person

Part #	Size (in.)	Part #	Size (in.)
LND4848	48 x 96	LND6448	64 x 96
LND4860	48 x 120	LND6460	64 x 120
LND4872	48 x 144	LND6472	64 x 144

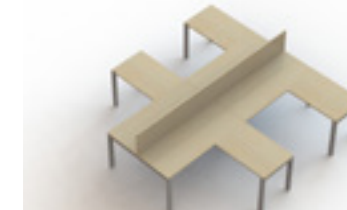

#### + Return

Part #	Size (in.)
R36	24 x 36



#### + Modesty

Part #	Size (in.)
M	to fit desk

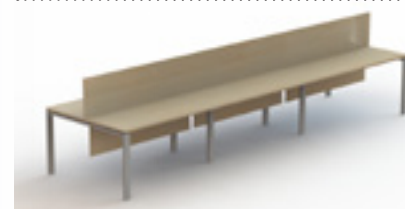

#### 6 Person

Part #	Size (in.)	Part #	Size (in.)
LNT4848	48 x 144	LNT6448	64 x 144
LNT4860	48 x 180	LNT6460	64 x 180
LNT4872	48 x 216	LNT6472	64 x 216

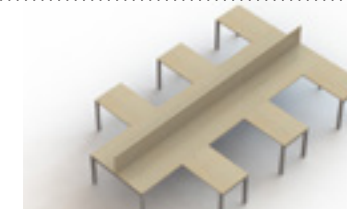

#### + Return

Part #	Size (in.)
R36	24 x 36



#### + Modesty

Part #	Size (in.)
M	to fit desk

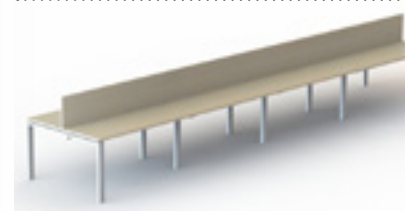

#### 8 Person

Part #	Size (in.)	Part #	Size (in.)
LNQ4848	48 x 192	LNQ6448	64 x 192
LNQ4860	48 x 240	LNQ6460	64 x 240
LNQ4872	48 x 288	LNQ6472	64 x 288



#### + Return

Part #	Size (in.)
R36	24 x 36



#### + Modesty

Part #	Size (in.)
M	to fit desk

# desks

## Tutor

The Tutor has been created to offer everyone solid convenience, excellent materials combined with simple ideas which, together, offer you furniture of indisputable quality.

### Specifications

#### Table Top

- 1" Industrial Grade Particleboard Core (45lbs foot density)
- High Pressure (HPL) scratch resistant laminate for longevity with balancing backer sheet.
- 3mm vinyl bonded edge

#### Table Frame

- Table end frames constructed of 3" diameter steel tube with steel cross bars. Modesty panel bolted to end frames and work surface
- Fully welded construction
- Adjustable floor glide
- Table height 29-1/2"

#### Colours & Finishes

- Durable powdercoat finish from MityBilt colour selection
- High Pressure Laminate and 3mm vinyl bonded edge from MityBilt colour selection
- See page 52 for MityBilt colours and finishes guide

#### Options

- Heights
- Finishes
- Modesty panels
- Castors

## Tutor / Desk



TUT3060 shown in Wild Cherry laminate and 3mm edge. Frame and modesty shown in black powder coat finish



Part #	Size (in.)
TUT2448	24 x 48
TUT2460	24 x 60
TUT2472	24 x 72
TUT3048	30 x 48
TUT3060	30 x 60
TUT3072	30 x 72
TUT3648	36 x 48
TUT3660	36 x 60
TUT3672	36 x 72

Icon is a new concept of a T leg table frame, in which design and functionality are in perfect harmony. Suiting a wide range of market needs, Icon offers full integral wire management with an impressive modern design.



IC3060R36 shown with optional return. Table top shown in Designer White laminate and 3mm edge. Frame shown in gloss white with accented orange powder coated wire management covers and modesty panel.

Specifications

Table Top

- 1" Industrial Grade Particleboard Core (45lbs foot density)
- High Pressure (HPL) scratch resistant laminate for longevity with balancing backer sheet
- 3mm vinyl bonded edge

Table Frame

- Modular construction
- A larger upright allows to accommodate a fixed beam to give greater stability to give greater structural stability
- Structural metal modesty in a range of colours
- Integral wire management throughout
- coloured vertical covers pressure fitted to main leg support allows for quick simple access for wire management
- Adjustable floor glides

Colours & Finishes

- Durable powdercoat finish from MityBilt colour selection
- High Pressure Laminate and 3mm vinyl bonded edge from MityBilt colour selection
- Featured cover and modesty colours below

Feature Colour Options

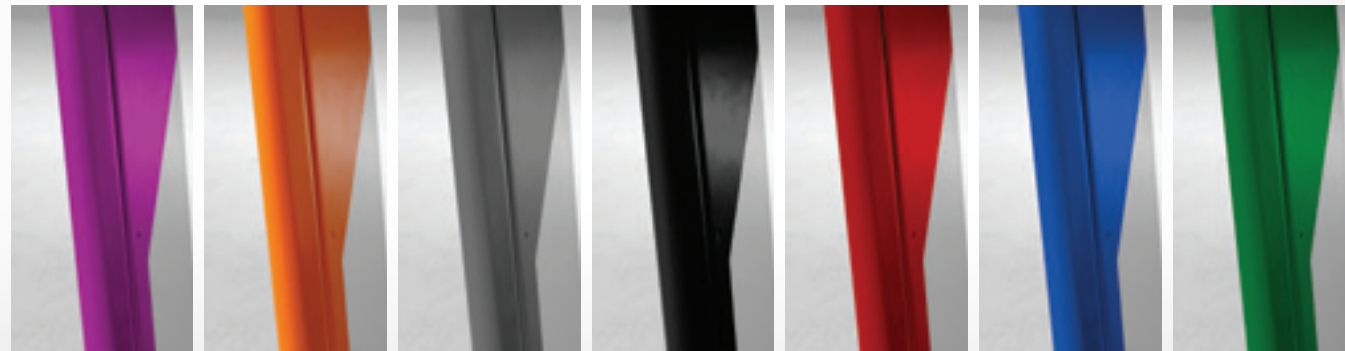

Purple Orange Grey Black Red Blue Green

Icon / Desk



Desk

Part #	Size (in.)
IC2448	24 x 48
IC2460	24 x 60
IC2472	24 x 72
IC3048	30 x 48
IC3060	30 x 60
IC3072	30 x 72

Icon / Return



Icon / Modesty



Return (optional)

Part #	Size (in.)
R36	24 x 36
R48	24 x 48

Modesty (optional)

Part #	Size (in.)
M	to fit desk

Wire Management





# Ultra

NEW

Ultra is a new approach offered by MityBilt to meet the demands of today's competitive workplace. Effective as a single desk with a range of options to make it a game changer. The desk boasts a full complement of vertical and horizontal wire management.



UL3060R36 shown with optional return. Table top shown in maple laminate and 3mm edge. Frame shown in silver powder coat finish.

## Specifications

### Table Top

- 1" Industrial Grade Particleboard Core (45lbs foot density)
- High Pressure (HPL) scratch resistant laminate for longevity with balancing backer sheet.
- 3mm vinyl bonded edge

### Table Frame

- Deep Drawn base with floor leveler
- Aesthetic cover to leg component
- Modular construction
- A larger upright allows to accommodate a fixed beam to give greater stability to the structure.
- Integral wire management
- Adjustable floor glides

### Colours & Finishes

- Durable powdercoat finish from MityBilt colour selection
- High Pressure Laminate and 3mm vinyl bonded edge from MityBilt colour selection

### Options

- Modesty panel
- CPU Holder

## Ultra / Desk

## Ultra / Return



### Desk

Part #	Size (in.)	Leg Style
UL2448	24 x 48	Center
UL2460	24 x 60	Center
UL2472	24 x 72	Center
UL3048	30 x 48	Offset
UL3060	30 x 60	Offset
UL3072	30 x 72	Offset

### Return (optional)

Part #	Size (in.)	Leg Style
R36	24 x 36	Center
R48	24 x 48	Center

# Ultra Plus

NEW

Ultra Plus allows for the creation of a continual work surface which is popular in office and IT environments. Each table frame gangs to a common supporting leg, creating extra work area without cluttering floor space and jeopardizing leg room with unnecessary supports.



## Ultra Plus / Desk

## Ultra Plus / Return



### Desk

Part #	Size (in.)
UPE2448	24 x 48
UPE2460	24 x 60
UPE2472	24 x 72
UPE3048	30 x 48

### Return

Part #	Size (in.)
P36	24 x 36

## Integral Wire Management System

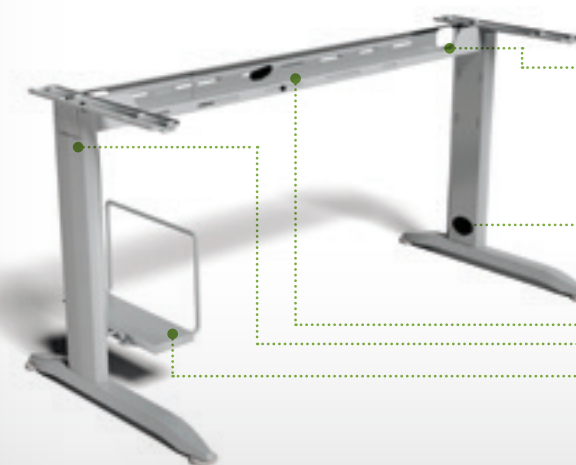

- Cut away front wire management channel allows for quick easy access of wires with table top on.
- Leg mounted grommets allow for hiding of wires inside the desk leg keeping your office smart and tidy.
- Structural wire management channel keeps wires and power bars organized and out of site.
- Knock out plates allow for continual flow of wires between tables when in a ganged configuration.
- Optional CPU holder fixes next to grommet for ultimate wire management.

# Pogo2

The Pogo2 is engineered to provide truly outstanding flexibility. An adjustable workspace allows the employee to individually adjust the table for their optimum comfort, producing increased productivity. Full adjustment is available even with an L-shape configuration. Now you have a stylish and ergonomic option in changing the way your work.

## Specifications

### Table Top

- 1" Industrial Grade Particleboard Core (45lbs foot density)
- High Pressure (HPL) scratch resistant laminate for longevity with balancing backer sheet.
- 3mm vinyl bonded edge

### Colours & Finishes

- Durable silver powdercoat finish
- High Pressure Laminate and 3mm vinyl bonded edge from MityBilt colour selection

### Options

- Modesty panel
- CPU holder

### Table Frame

- Aesthetic cover to leg component
- Modular construction
- **16" of adjustment. 26" - 42"**
- Integral wire management
- Adjustable floor glides

## Pogo2 / Adjustable Height Desk

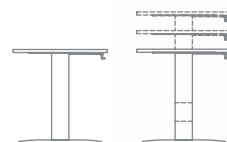

Desk shown with optional return. POG3060R36 shown in Wild Cherry laminate and 3mm edge. Frame shown in silver powder coat finish.

### Desk

Part #	Size (in.)
POG2436	24 x 36
POG2448	24 x 48
POG3048	30 x 48
POG3060	30 x 60

### Return (optional)

Part #	Size (in.)
R36	24 x 36
R48	24 x 48

# Razor

The Razor provides an economical adjustable height work surface, an excellent choice for an ergonomic work station or a wheelchair accessible desk.

## Specifications

### Table Top

- 1" Industrial Grade Particleboard Core (45lbs foot density)
- High Pressure (HPL) scratch resistant laminate for longevity with balancing backer sheet.
- 3mm vinyl bonded edge

### Colours & Finishes

- Durable powdercoat finish from MityBilt colour selection
- High Pressure Laminate and 3mm vinyl bonded edge from MityBilt colour selection

### Options

- Castors
- Finishes

### Table Frame

- Offset style leg
- **12" of adjustment. 24" - 36"**
- Adjustable floor glides

## Razor / Adjustable Height Desk



RAZ2436 shown in Fusion Maple laminate and silver 3mm edge. Frame shown in silver powder coat finish.



Part #	Size (in.)
RAZ2436	24 x 36
RAZ2448	24 x 48
RAZ2460	24 x 60
RAZ3048	30 x 48

Etch is a distinctive range of tables featuring a premium profile frame. Etch embodies a stealthy and highly modern look that is sure to impress any guest.

### Specifications

#### Table Top

- 1" Industrial Grade Particleboard Core (45lbs foot density)
- High Pressure (HPL) scratch resistant laminate for longevity with balancing backer sheet.
- 3mm vinyl bonded edge

#### Table Frame

- Laser-cut 6mm profile frame
- Fully welded construction

#### Colours & Finishes

- Durable silver powdercoat finish
- High Pressure Laminate and 3mm vinyl bonded edge from MityBilt colour selection

#### Options

- Finishes

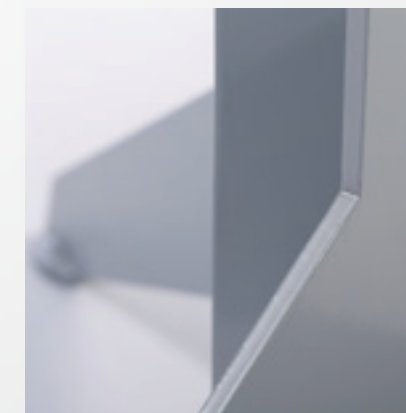

### Etch / Rectangle

ET3084 shown in Fusion Maple laminate and Silver 3mm edge. Frame shown in Silver powder coat finish



The Etch rectangle features a double base support and can seat up to 8 individuals with ample work space.

#### Rectangle

Part #	Size (in.)
ET3060	30 x 60
ET3072	30 x 72
ET3096	30 x 96
ET3660	36 x 60
ET3672	36 x 72
ET3696	36 x 96
ET4860	48 x 60
ET4872	48 x 72
ET4896	48 x 96



### Etch / Round

ET36R shown in Cosmick Strands laminate and charcoal 3mm edge. Frame shown in Silver powder coat finish

Designed for closer interaction between fewer people.

#### Round

Part #	Diameter (in.)
ET36R	36
ET42R	42
ET48R	48
ET60R	60

# Stride

NEW

The Stride is an eye catching range of tables all using a distinct leg design. The tapered steel leg profile provides an elegant, modern and clean touch to any office space.

## Specifications

### Table Top

- 1" Industrial Grade Particleboard Core (45lbs foot density)
- High Pressure (HPL) scratch resistant laminate for longevity with balancing backer sheet
- 3mm vinyl bonded edge

### Colours & Finishes

- Durable silver powdercoat finish
- High Pressure Laminate and 3mm vinyl bonded edge from MityBilt colour selection

### Table Frame

- Contour style steel legs
- Modular construction
- Adjustable floor glides

### Options

- Laminate Finish
- Edge Finish
- Modesty Panel
- Rounded Corners

## Stride / Racetrack

A good choice for larger group meetings. The popular racetrack style can seat 4 - 6 with ample work space.



ST3672 shown in Cosmick strands laminate and charcoal 3mm edge. Frame shown in Silver powder coat finish

Part #	Size (in.)
ST3048	30 x 48
ST3060	30 x 60
ST3072	30 x 72
ST3096	30 x 96
ST3648	36 x 48
ST3660	36 x 60
ST3672	36 x 72
ST3696	36 x 96

## Stride / Square

A convenient meeting table for up to 4 people



ST3636 shown in Cosmick Strands laminate and charcoal 3mm edge. Frame shown in Silver powder coat finish

Part #	Size (in.)
ST3636	36 x 36
ST4242	42 x 42
ST4848	48 x 48
ST6060	60 x 60

## Stride / Round

Designed for closer interaction between fewer people. Accommodates up to 3 people.



ST36R shown in Cosmick Strands laminate and charcoal 3mm edge. Frame shown in Silver powder coat finish

Part #	Diameter (in.)
ST36R	36
ST42R	42
ST48R	48
ST60R	60

# Neon

NEW

Neon is simplistically designed yet practical and stylish. Attention to detail is what makes this a great design featuring an oval profile tube on a vertical plane foot. Neon will effortlessly blend in with any office work space that calls for a functional yet clean appearance.

## Specifications

### Table Top

- 1" Industrial Grade Particleboard Core (45lbs foot density)
- High Pressure (HPL) scratch resistant laminate for longevity with balancing backer sheet
- 3mm vinyl bonded edge

### Colours & Finishes

- Durable powdercoat finish from MityBilt colour selection
- High Pressure Laminate and 3mm vinyl bonded edge from MityBilt colour selection

### Table Frame

- 16 gauge Oval profile steel tube fixed to 3/8" steel plate
- Fully welded construction
- Adjustable floor glide
- Table height 29-1/2"

### Options

- Heights
- Finishes
- Modesty Panel
- Rounded Corners
- Flip Top

## Neon / Table



NE3060 shown in Fusion Maple laminate and 3mm edge. Frame shown in gloss white powder coat finish.

Part #	Size (in.)
NE2436	24 x 36
NE2448	24 x 48
NE2460	24 x 60
NE2472	24 x 72
NE2496	24 x 96
NE3036	30 x 36
NE3048	30 x 48
NE3060	30 x 60
NE3072	30 x 72
NE3096	30 x 96
NE3648	36 x 48
NE3660	36 x 60
NE3672	36 x 72
NE3696	36 x 96

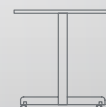

# Lavo

What makes Lavo unique is its ability to respond to the needs of an entire organization and maintain continuity of style. The Lavo system offers alternate base designs – combine the designs and maintain the style.

## Specifications

### Table Top

- 1" Industrial Grade Particleboard Core (45lbs foot density)
- High Pressure (HPL) scratch resistant laminate for longevity with balancing backer sheet.
- 3mm vinyl bonded edge

### Colours & Finishes

- Durable powdercoat finish from MityBilt colour selection
- High Pressure Laminate and 3mm vinyl bonded edge from MityBilt colour selection

### Table Frame

- 16 gauge Oval profile steel tube
- Fully welded construction
- Adjustable floor glide
- Table height 29-1/2"

### Options

- Heights
- Finishes
- Castors
- Rounded Corners
- Modesty Panel
- Flip Top

## Lavo / Center



### Center

Part #	Size (in.)
LAVC2436	24 x 36
LAVC2448	24 x 48
LAVC2460	24 x 60
LAVC2472	24 x 72
LAVC2496	24 x 96
LAVC3036	30 x 36
LAVC3048	30 x 48
LAVC3060	30 x 60
LAVC3072	30 x 72
LAVC3096	30 x 96
LAVC3648	36 x 48
LAVC3660	36 x 60
LAVC3672	36 x 72
LAVC3696	36 x 96

## Lavo / Offset



### Offset

Part #	Size (in.)
LAVOS2436	24 x 36
LAVOS2448	24 x 48
LAVOS2460	24 x 60
LAVOS2472	24 x 72
LAVOS2496	24 x 96
LAVOS3036	30 x 36
LAVOS3048	30 x 48
LAVOS3060	30 x 60
LAVOS3072	30 x 72
LAVOS3096	30 x 96
LAVOS3648	36 x 48
LAVOS3660	36 x 60
LAVOS3672	36 x 72
LAVOS3696	36 x 96

# Vitesse

In its simplest form, Vitesse exists as a freestanding table, logical in concept and design. Vitesse is an intelligent response to the demands of most popular methods of work and conference, introducing order and simplicity to complex environments.

## Specifications

### Table Top

- 1" Industrial Grade Particleboard Core (45lbs foot density)
- High Pressure (HPL) scratch resistant laminate for longevity with balancing backer sheet.
- 3mm vinyl bonded edge

### Colours & Finishes

- Durable powdercoat finish from MityBilt colour selection
- High Pressure Laminate and 3mm vinyl bonded edge from MityBilt colour selection

### Table Frame

- 16 gauge 2" diameter steel tube
- Fully mig welded construction
- Work surface mounting to oversize steel plates
- Adjustable floor glide
- Table height 29-1/2"

### Options

- Heights
- Finishes
- Castors
- Rounded Corners
- Modesty Panel
- Flip Top
- Custom Sizes

## Vitesse / I



VIT12460 shown in Fusion Maple laminate and 3mm edge. Frame shown in Black powder coat finish.



Part #	Size (in.)
VIT12436	24 x 36
VIT12448	24 x 48
VIT12460	24 x 60
VIT12472	24 x 72
VIT12496	24 x 96
VIT13036	30 x 36
VIT13048	30 x 48
VIT13060	30 x 60
VIT13072	30 x 72
VIT13096	30 x 96

## Vitesse / H



VITH2448 shown in Wild Cherry laminate and Black 3mm edge. Frame shown in Black powder coat finish.



Part #	Size (in.)
VITH2436	24 x 36
VITH2448	24 x 48
VITH2460	24 x 60
VITH2472	24 x 72
VITH2496	24 x 96
VITH3036	30 x 36
VITH3048	30 x 48
VITH3060	30 x 60
VITH3072	30 x 72
VITH3096	30 x 96

## Vitesse / II



VIT23060 shown in Designer White laminate and 3mm edge. Frame shown in Charcoal powder coat finish.



Part #	Size (in.)
VIT22436	24 x 36
VIT22448	24 x 48
VIT22460	24 x 60
VIT22472	24 x 72
VIT22496	24 x 96
VIT23036	30 x 36
VIT23048	30 x 48
VIT23060	30 x 60
VIT23072	30 x 72
VIT23096	30 x 96
VIT23636	36 x 36
VIT23648	36 x 48
VIT23660	36 x 60
VIT23672	36 x 72
VIT23696	36 x 96

# Quadra

With Quadra, the focus is in the detail. Both practical and aesthetic, Quadra performs with a confidence that our designers have honed from long experience. The Quadra Twist has all the attributes and strengths of the Quadra – but with a twist!

## Specifications

### Table Top

- 1" Industrial Grade Particleboard Core (45lbs foot density)
- High Pressure (HPL) scratch resistant laminate for longevity with balancing backer sheet.
- 3mm vinyl bonded edge

### Colours & Finishes

- Durable powdercoat finish from MityBilt colour selection
- High Pressure Laminate and 3mm vinyl bonded edge from MityBilt colour selection

### Table Frame

- 16 gauge 2" x 1" rectangular profile steel with 2" diameter steel legs
- Fully welded end frame bolted to under table support
- Adjustable floor glide
- Table height 29-1/2"

### Options

- Heights
- Finishes
- Castors
- Rounded Corners
- Modesty Panel

## Quadra / Acute

NEW



QAC3060 shown in Fusion Maple laminate and 3mm edge. Frame shown in Silver powder coat finish

Part #	Size (in.)
QAC2436	24 x 36
QAC2448	24 x 48
QAC2460	24 x 60
QAC2472	24 x 72
QAC2496	24 x 96
QAC3036	30 x 36
QAC3048	30 x 48
QAC3060	30 x 60
QAC3072	30 x 72
QAC3096	30 x 96
QAC3648	36 x 48
QAC3660	36 x 60
QAC3672	36 x 72
QAC3696	36 x 96
QAC4848	48 x 48
QAC4860	48 x 60
QAC4872	48 x 72
QAC4896	48 x 96



## Quadra / Twist



QTW3060 shown in Wild Cherry laminate and 3mm edge. Frame shown in Silver powder coat finish

Part #	Size (in.)
QTW2436	24 x 36
QTW2448	24 x 48
QTW2460	24 x 60
QTW2472	24 x 72
QTW2496	24 x 96
QTW3036	30 x 36
QTW3048	30 x 48
QTW3060	30 x 60
QTW3072	30 x 72
QTW3096	30 x 96
QTW3648	36 x 48
QTW3660	36 x 60
QTW3672	36 x 72
QTW3696	36 x 96
QTW4848	48 x 48
QTW4860	48 x 60
QTW4872	48 x 72
QTW4896	48 x 96



## Quadra / Standard



QUA3060 top shown in Fusion Maple laminate and 3mm edge. Frame shown in Black powder coat finish

Part #	Size (in.)
QUA2436	24 x 36
QUA2448	24 x 48
QUA2460	24 x 60
QUA2472	24 x 72
QUA2496	24 x 96
QUA3036	30 x 36
QUA3048	30 x 48
QUA3060	30 x 60
QUA3072	30 x 72
QUA3096	30 x 96
QUA3648	36 x 48
QUA3660	36 x 60
QUA3672	36 x 72
QUA3696	36 x 96
QUA4848	48 x 48
QUA4860	48 x 60
QUA4872	48 x 72
QUA4896	48 x 96



# Espire

The Espire leg system can handle any situation, from a minimalist appearance of a 2" diameter leg to a 3" diameter column. Espire works great in the office or conference room.

## Specifications

### Table Top

- 1" Industrial Grade Particleboard Core (45lbs foot density)
- High Pressure (HPL) scratch resistant laminate for longevity with balancing backer sheet
- 3mm vinyl bonded edge

### Colours & Finishes

- Durable powdercoat finish from MityBilt colour selection
- High Pressure Laminate and 3mm vinyl bonded edge from MityBilt colour selection

### Table Frame

- 16 gauge steel tube
- adjustable floor glide
- table height 29-1/2"
- See individual product for leg specifications

### Options

- Heights
- Finishes
- Rounded Corners
- Modesty Panel

## Espire / II



E3060 shown in Maple laminate and 3mm edge. Legs shown in Silver powder coat finish.

Part #	Size (in.)
E2436	24 x 36
E2448	24 x 48
E2460	24 x 60
E3036	30 x 36
E3048	30 x 48
E3060	30 x 60
E3636	36 x 36
E3648	36 x 48
E3660	36 x 60

## Espire / Mobile



Locking heavy duty casters



E3060CA shown in Maple laminate and 3mm edge. Legs shown in Silver powder coat finish.

Part #	Size (in.)
E2436CA	24 x 36
E2448CA	24 x 48
E2460CA	24 x 60
E3036CA	30 x 36
E3048CA	30 x 48
E3060CA	30 x 60
E3636CA	36 x 36
E3648CA	36 x 48
E3660CA	36 x 60

## Espire / III



E33060 shown in Wild Cherry laminate and 3mm edge. Legs shown in Black powder coat finish.

Part #	Size (in.)
E32436	24 x 36
E32448	24 x 48
E32460	24 x 60
E33036	30 x 36
E33048	30 x 48
E33060	30 x 60
E33636	36 x 36
E33648	36 x 48
E33660	36 x 60



# Espire

Espire Take Off Leg, a quality “stack ‘n’ store” table designed for quick and easy set up and take down, perfect for conference rooms!



## Espire / Take Off Leg

### Specifications

- 2" Diameter 16 gauge leg
- leg bolted to mechanism
- high quality removable leg mechanism
- Complete with integral rubber bumper to protect table surfaces when stacked



Part #	Size (in.)
ESTO2436	24 x 36
ESTO2448	24 x 48
ESTO2460	24 x 60
ESTO2472	24 x 72
ESTO2496	24 x 96
ESTO3036	30 x 36
ESTO3048	30 x 48
ESTO3060	30 x 60
ESTO3072	30 x 72
ESTO3096	30 x 96
ESTO3636	36 x 36
ESTO3648	36 x 48
ESTO3660	36 x 60
ESTO3672	36 x 72
ESTO3696	36 x 96
ESTO36R	36 Dia.
ESTO42R	42 Dia.
ESTO48R	48 Dia.
ESTO60R	60 Dia.

## Espire / Folding Leg

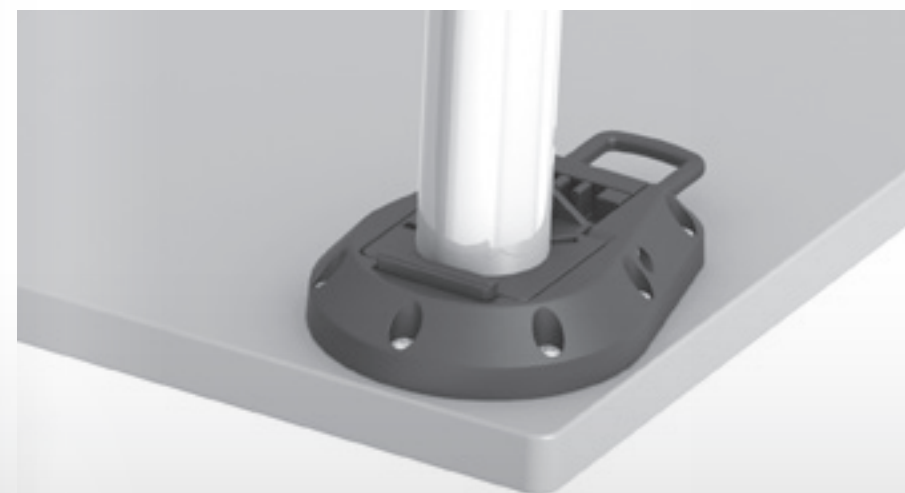

Table top shown in Designer White laminate and 3mm edge. Legs shown in Silver powder coat finish



### Specifications

- 2" Diameter 16 gauge leg
- leg bolted to mechanism
- high quality dual locking folding mechanism
- Complete with integral rubber bumper to protect table surfaces when stacked



Part #	Size (in.)
ESF2436	24 x 36
ESF2448	24 x 48
ESF2460	24 x 60
ESF2472	24 x 72
ESF2496	24 x 96
ESF3036	30 x 36
ESF3048	30 x 48
ESF3060	30 x 60
ESF3072	30 x 72
ESF3096	30 x 96
ESF3636	36 x 36
ESF3648	36 x 48
ESF3660	36 x 60
ESF3672	36 x 72
ESF3696	36 x 96
ESF36R	36 Dia.
ESF42R	42 Dia.
ESF48R	48 Dia.
ESF60R	60 Dia.

# Classic

When it comes to rugged durability the Classic table stands alone, offering exceptional strengths that an industrious environment demands. We created the Classic the obvious way... first we listened to you, then we designed ours. Classic.

## Specifications

### Table Top

- 1" Industrial Grade Particleboard Core (45lbs foot density)
- High Pressure (HPL) scratch resistant laminate for longevity with balancing backer sheet.
- 3mm vinyl bonded edge

### Colours & Finishes

- Durable powdercoat finish from MityBilt colour selection
- High Pressure Laminate and 3mm vinyl bonded edge from MityBilt colour selection

### Options

- Heights
- Finishes
- Castors
- Rounded Corners
- Modesty Panel

### Table Frame

- Table frame constructed of 1" x 3" x 1" channel section, with integral "pozi lok" corner bracket and 1-1/4" x 1-1/4" steel legs. Leg retention by support on each leg face and locking set screw
- Heavy duty steel adjustable floor glide with rubber cush-ion and non-removable foot
- Adjustable floor glide
- Table height 29-1/2"

## Classic / Rectangle



RTA2460 shown in Designer White laminate and Black 3mm edge. Frame shown in Black powder coat finish

Part #	Size (in.)
RTA2424	24 x 24
RTA2430	24 x 30
RTA2436	24 x 36
RTA2448	24 x 48
RTA2460	24 x 60
RTA2472	24 x 72
RTA2496	24 x 96
RTA3030	30 x 30
RTA3036	30 x 36
RTA3048	30 x 48
RTA3060	30 x 60
RTA3072	30 x 72
RTA3096	30 x 96
RTA3636	36 x 36
RTA3648	36 x 48
RTA3660	36 x 60
RTA3672	36 x 72
RTA3696	36 x 96
RTA4848	48 x 48
RTA4860	48 x 60
RTA4872	48 x 72
RTA4896	48 x 96

## Classic / Round



RTA60R shown in Fusion Maple laminate and 3mm edge. Frame shown in Black powder coat finish

Part #	Diameter (in.)
RTA30R	30
RTA36R	36
RTA42R	42
RTA48R	48
RTA60R	60

## Classic / Trapezoid



RTA48Z shown in Wild Cherry laminate and Silver 3mm edge. Frame shown in Silver powder coat finish.

Part #	Size (in.)
RTA48Z	24 x 48
RTA60Z	30 x 60
RTA72Z	36 x 72

## Classic / 180



RTA48-180 shown in Studio Teak laminate and Silver 3mm edge. Frame shown in Silver powder coat finish.

Part #	Size (in.)
RTA48-180	24 x 48
RTA60-180	30 x 60
RTA72-180	36 x 72

flip top

# Meso

NEW

## Specifications

### Table Top

- 1" Industrial Grade Particleboard Core (45lbs foot density)
- High Pressure (HPL) scratch resistant laminate for longevity with balancing backer sheet
- 3mm vinyl bonded edge

### Colours & Finishes

- High Pressure Laminate and 3mm vinyl bonded edge from MityBilt colour selection

### Table Frame

- Complete steel construction
- Triangular steel profile legs
- Lateral one handed operation
- Safety lock in open position
- Straight nesting for efficient storage
- Large locking casters for smooth and easy movement

### Options

- Modesty Panel
- Rounded Corners
- Non-Flip top

### Additional Table Shapes

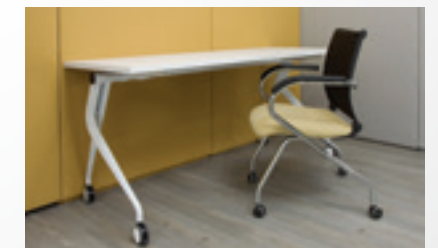

## Meso / Flip Top



ME2460 shown in Studio Teak laminate and 3mm edge. Frame shown in White powder coat finish

Part #	Size (in.)
ME2448	24 x 48
ME2460	24 x 60
ME2472	24 x 72
ME3048	30 x 48
ME3060	30 x 60
ME3072	30 x 72

# Neon

NEW

Neon is simplistically designed yet practical and stylish. Attention to detail is what makes this a great design featuring an oval profile tube on a vertical profile. Neon will effortlessly blend in with any office work space that calls for a functional yet clean appearance.

## Specifications

### Table Top

- 1" Industrial Grade Particleboard Core (45lbs foot density)
- High Pressure (HPL) scratch resistant laminate for longevity with balancing backer sheet.
- 3mm vinyl bonded edge

### Colours & Finishes

- Durable powdercoat finish from MityBilt colour selection
- High Pressure Laminate and 3mm vinyl bonded edge from MityBilt colour selection

### Table Frame

- 16 gauge Oval profile steel tube on 3/8" steel plate
- Fully welded construction
- High quality flip top mechanism with vertical locking facility
- Integral bump stop for surface protection when in nested position
- Nesting for efficient storage
- high quality locking casters for smooth and easy movement
- Table height 29-1/2"

### Options

- Heights
- Finishes
- Modesty Panel
- Rounded Corners
- Non-Flip Top

### Additional Table Shapes



## Neon / Flip Top



NFT3060 shown in Fusion Maple laminate and 3mm edge. Frame shown in gloss White powder coat finish.

Part #	Size (in.)
NFT2448	24 x 48
NFT2460	24 x 60
NFT2472	24 x 72
NFT3048	30 x 48
NFT3060	30 x 60
NFT3072	30 x 72
NFT3648	36 x 48
NFT3660	36 x 60
NFT3672	36 x 72



# Zest

The innovative Zest table supports modern work dynamics making it a superb choice for conference, office, meeting and training facilities as well as meeting the demand for extra work space or projects. Zest creates extra workspace at a moments notice, and is particularly effective where there is a need for flexible use of space with optional working lay-outs, and has the ability to create extra space through the compact storage of the tables.

## Specifications

### Table Top

- 1" Industrial Grade Particleboard Core (45lbs foot density)
- High Pressure (HPL) scratch resistant laminate for longevity with balancing backer sheet
- 3mm vinyl bonded edge

### Colours & Finishes

- Durable powdercoat finish from MityBilt colour selection
- High Pressure Laminate and 3mm vinyl bonded edge from MityBilt colour selection

### Table Frame

- 16 gauge 2-1/2" diameter steel tube with GRP base
- Fully welded construction
- High quality flip top mechanism with vertical locking facility
- Integral bump stop for surface protection when in nested position
- Nesting for efficient storage
- high quality locking casters for smooth and easy movement
- Table height 29-1/2"

### Options

- Heights
- Finishes
- Modesty Panel
- Rounded Corners
- Non-Flip top

### Additional Table Shapes



## Zest / Flip Top



ZFT2448 shown in Studio Teak laminate and 3mm edge. Frame shown in Silver powder coat finish

Part #	Size (in.)
ZFT2448	24 x 48
ZFT2460	24 x 60
ZFT2472	24 x 72
ZFT3048	30 x 48
ZFT3060	30 x 60
ZFT3072	30 x 72
ZFT3648	36 x 48
ZFT3660	36 x 60
ZFT3672	36 x 72



# Lavo

What makes Lavo unique is its ability to respond to the needs of an entire organization and maintain continuity of style. The Lavo system offers alternate base designs – combine the designs and still maintain the style.

## Specifications

### Table Top

- 1" Industrial Grade Particleboard Core (45lbs foot density)
- High Pressure (HPL) scratch resistant laminate for longevity with balancing backer sheet
- 3mm vinyl bonded edge

### Table Frame

- 16 gauge oval profile steel tube
- Fully welded construction
- High quality flip top mechanism with vertical locking facility
- Integral bump stop for surface protection when in nested position
- Nesting for efficient storage
- high quality locking casters for smooth and easy movement
- Table height 29-1/2"

### Colours & Finishes

- Durable powdercoat finish from MityBilt colour selection
- High Pressure Laminate and 3mm vinyl bonded edge from MityBilt colour selection

### Options

- Heights
- Finishes
- Modesty Panel
- Rounded Corners
- Non-Flip top

### Additional Table Shapes



## Lavo / Flip Top



LFT2448 shown in Studio Teak laminate and 3mm edge. Frame shown in Charcoal powder coat finish



Part #	Size (in.)
LFT2448	24 x 48
LFT2460	24 x 60
LFT2472	24 x 72
LFT3048	30 x 48
LFT3060	30 x 60
LFT3072	30 x 72
LFT3648	36 x 48
LFT3660	36 x 60
LFT3672	36 x 72

# Vitesse

In its simplest form, VITESSE exists as a freestanding table, logical in concept and design. Vitesse is an intelligent response to the demands of most popular methods of work and conference, introducing order and simplicity to complex environments.

## Specifications

### Table Top

- 1" Industrial Grade Particleboard Core (45lbs foot density)
- High Pressure (HPL) scratch resistant laminate for longevity with balancing backer sheet.
- 3mm vinyl bonded edge

### Colours & Finishes

- Durable powdercoat finish from MityBilt colour selection
- High Pressure Laminate and 3mm vinyl bonded edge from MityBilt colour selection

### Table Frame

- 16 gauge 2" diameter steel tube
- Fully welded construction
- High quality flip top mechanism with vertical locking facility
- Integral bump stop for surface protection when in nested position
- Nesting for efficient storage
- high quality locking casters for smooth and easy movement
- Table height 29-1/2"

### Options

- Heights
- Finishes
- Modesty Panel
- Rounded Corners
- Non-Flip top

### Additional Table Shapes



## Vitesse / Flip Top



VFT3060 shown in Sterling Ash laminate and charcoal 3mm edge. Frame shown in Charcoal powder coat finish



Part #	Size (in.)
LFT2448	24 x 48
LFT2460	24 x 60
LFT2472	24 x 72
LFT3048	30 x 48
LFT3060	30 x 60
LFT3072	30 x 72
LFT3648	36 x 48
LFT3660	36 x 60
LFT3672	36 x 72



# pedestals

## Solo

MityBilt table bases are designed to make things simple, allowing you to create the layout and ambiance you want.

### Specifications

#### Table Top

- 1" Industrial Grade Particleboard Core (45lbs foot density)
- High Pressure (HPL) scratch resistant laminate for longevity with balancing backer sheet
- 3mm vinyl bonded edge

#### Table Frame

- Table frame constructed from 4" diameter steel center column
- Flat steel base
- Fully welded construction

#### Colours & Finishes

- Durable powdercoat finish from MityBilt colour selection
- High Pressure Laminate and 3mm vinyl bonded edge from MityBilt colour selection

#### Options

- Heights
- Finishes

### Solo / 30" / 42" Height

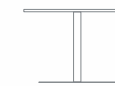

#### 30" Height

Part #	Size (in.)
SOL24	24 Round or Square
SOL30	30 Round or Square
SOL36	36 Round or Square
SOL42	42 Round or Square
SOL48R	48 Round only

#### 42" Height

Part #	Size (in.)
SOL24-42	24 Round or Square
SOL30-42	30 Round or Square
SOL36-42	36 Round or Square

### Triple Solo / 30" / 42" Height



NEW



#### Triple Solo 30" Height

Part #	Size (in.)
TSOL2472	24 x 72
TSOL2484	24 x 84
TSOL2496	24 x 96
TSOL3072	30 x 72
TSOL3084	30 x 84
TSOL3096	30 x 96

#### Triple Solo 42" Height

Part #	Size (in.)
TSOL2472	24 x 72
TSOL2484	24 x 84
TSOL2496	24 x 96
TSOL3072	30 x 72
TSOL3084	30 x 84
TSOL3096	30 x 96

# Café-x

The modern workplace demands flexible solutions. Create an environment using our design orientated selection of contemporary tables.

## Specifications

### Table Top

- 1" Industrial Grade Particleboard Core (45lbs foot density)
- High Pressure (HPL) scratch resistant laminate for longevity with balancing backer sheet
- 3mm vinyl bonded edge

### Table Frame

- 16 Gauge 4" Diameter steel center column
- Horizontal tubular base from 16 gauge 2" diameter steel and steel end caps
- Fully welded construction
- Adjustable floor glides

### Colours & Finishes

- Durable powdercoat finish from MityBilt colour selection
- High Pressure Laminate and 3mm vinyl bonded edge from MityBilt colour selection

### Options

- Heights
- Finishes
- Castors

## Café-x / 30" Height

## Café-x / 42" Height



CAF36 shown in Fusion Maple laminate with Silver 3mm edge and powder coat frame.



CAF36-42 shown in Fusion Maple laminate with Silver 3mm edge and powder coat frame.



### 30" Height

Part #	Size (in.)
CAF24	24 Round or Square
CAF30	30 Round or Square
CAF36	36 Round or Square
CAF42	42 Round or Square
CAF48	48 Round only

### 42" Height

Part #	Size (in.)
CAF24-42	24 Round or Square
CAF30-42	30 Round or Square
CAF36-42	36 Round only

# Cosmo-x

The modern workplace demands flexible solutions. Create an environment using our design orientated selection of contemporary tables.

## Specifications

### Table Top

- 1" Industrial Grade Particleboard Core (45lbs foot density)
- High Pressure (HPL) scratch resistant laminate for longevity with balancing backer sheet
- 3mm vinyl bonded edge

### Table Frame

- 16 gauge 2" diameter steel, horizontal tubular base with steel end caps
- Fully welded construction
- Adjustable floor glides

### Colours & Finishes

- Durable powdercoat finish from MityBilt colour selection
- High Pressure Laminate and 3mm vinyl bonded edge from MityBilt colour selection

### Options

- Heights
- Finishes
- Castors

## Cosmo-x / 30" Height

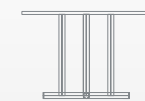

COS60 shown in Fusion Maple laminate and 3mm edge with Black powder coat frame

Part #	Size (in.)
COS36	36 Round or Square
COS42	42 Round or Square
COS48	48 Round or Square
COS60	60 Round or Square

# Bistro

NEW

The Bistro table is impressive in both style and functionality. The Bistro bar height table creates a rich atmosphere that lends itself to warm interaction. Its ability to nest, makes it unique yet highly functional, allowing for compact storage for space saving purposes.

## Specifications

### Table Top

- 1" Industrial Grade Particleboard Core (45lbs foot density)
- High Pressure (HPL) scratch resistant laminate for longevity with balancing backer sheet
- 3mm vinyl bonded edge

### Table Frame

- 16 gauge 2" Diameter center column
- 16 gauge 1-1/8" diameter legs
- non-slip and non-marking glides
- High quality flip top mechanism with vertical locking facility
- Integral bump stop for surface protection when in nested position

### Colours & Finishes

- Durable powdercoat finish from MityBilt colour selection
- High Pressure Laminate and 3mm vinyl bonded edge from MityBilt colour selection

### Options

- Heights
- Finishes
- Non flip top

## Bistro / Table



BIS24 shown in Fusion Maple laminate with Silver 3mm edge and powder coat frame

Part #	Size (in.)
BIS24	24 Round or Square
BIS30	30 Round or Square
BIS36	36 Round or Square

# Tango

Tango's ability to adjust in height in a moment's notice makes it a preferred choice for trainers and educators who are always on the move. Sit at it while working on your laptop, or adjust up to 42" for an ergonomic standing position. Wherever you go, the Tango can easily follow.

## Specifications

### Table Top

- 1" Industrial Grade Particleboard Core (45lbs foot density)
- High Pressure (HPL) scratch resistant laminate for longevity with balancing backer sheet
- 3mm vinyl bonded edge

### Table Frame

- 2" diameter ratchet style adjustable height mechanism
- Supported by Laser cut 3/8" steel plate
- Adjustable height 31" - 43"

### Colours & Finishes

- High Pressure Laminate and 3mm vinyl bonded edge from MityBilt colour selection

### Options

- Fixed heights
- Finishes

## Tango-X



TX24 shown in Designer White laminate with Silver 3mm edge and powder coat frame

## Tango-C



TC24 shown in Designer White laminate with Silver 3mm edge and powder coat frame

### Tango-X

Part #	Size (in.)
TX24	24 Round or Square
TX30	30 Round or Square
TX36	36 Round only

### Tango-C

Part #	Size (in.)
TC24	24 Round or Square
TC30	30 Round or Square
TC36	36 Round only

### Tango-D (not shown)

Part #	Diameter (in.)
TCD24	24
TCD30	30



# cafeteria & side tables

## Side

NEW

Form and function converge in a well fabricated metal frame table. Sleek in design with a touch of architectural style. Side looks good in any office or reception space.

### Specifications

#### Table Top

- 1" Industrial Grade Particleboard Core (45lbs foot density)
- High Pressure (HPL) scratch resistant laminate for longevity with balancing backer sheet
- 3mm vinyl bonded edge

#### Colours & Finishes

- Durable powdercoat finish from MityBilt colour selection
- High Pressure Laminate and 3mm vinyl bonded edge from MityBilt colour selection

#### Table Frame

- 16" Gauge steel 1" square tube
- Fully welded construction
- Plastic floor glide
- Table height 18"

#### Options

- Heights
- Finishes

### Side / Illusion

Illusion shown in Designer White laminate and 3mm edge with Silver powder coat finish.



#### Illusion

Part #	Size (in.)
STIL1818	18 x 18
STIL2424	24 x 24
STIL2430	24 x 30
STIL2436	24 x 36
STIL3030	30 x 30

### Side / Flat

Flat shown in Wild Cherry laminate and 3mm edge with Silver powder coat finish.



#### Flat

Part #	Size (in.)
STFT1818	18 x 18
STFT2424	24 x 24
STFT2430	24 x 30
STFT2436	24 x 36
STFT3030	30 x 30

# Side

NEW

## Specifications

### Table Top

- 1" Industrial Grade Particleboard Core (45lbs foot density)
- High Pressure (HPL) scratch resistant laminate for longevity with balancing backer sheet
- 3mm vinyl bonded edge

### Colours & Finishes

- Durable powdercoat finish from MityBilt colour selection
- High Pressure Laminate and 3mm vinyl bonded edge from MityBilt colour selection

### Table Frame

- 16" Gauge steel 1-1/4" diameter tube
- Fully welded construction
- Work surface mounted to profile steel fixing plate
- Plastic floor glide
- Table height 18"

### Options

- Heights
- Finishes

## Side / Quaver



Shown in Fusion Maple laminate with Silver 3mm edge and powder coated frame

### Quaver

Part #	Size (in.)
STQV	25 x 25

## Side / Rain



Shown in Fusion Maple laminate with Silver 3mm edge and powder coated frame

### Rain

Part #	Size (in.)
STRN	24 x 30

# Brunch

NEW

## Specifications

### Table Top

- 1" Industrial Grade Particleboard Core (45lbs foot density)
- High Pressure (HPL) scratch resistant laminate for longevity with balancing backer sheet
- 3mm vinyl bonded edge

### Colours & Finishes

- Durable powdercoat finish from MityBilt colour selection
- High Pressure Laminate and 3mm vinyl bonded edge from MityBilt colour selection

### Table Frame

- 16" Gauge steel 2" diameter steel tube
- Fully welded construction
- Table height 29-1/2"
- Kudos style seating

## Brunch / Duo



## Brunch / Quad

### Duo

Part #	Size (in.)
B2-2424	24 x 24

### Quad

Part #	Size (in.)
B4-2448	24 x 48

# Colour Swatches

## High Pressure Laminates

Many more options available upon request. Please contact MityBilt for larger samples.



Fusion Maple Bannister Oak Wild Cherry Cafelle Grey Nebula Asian Night

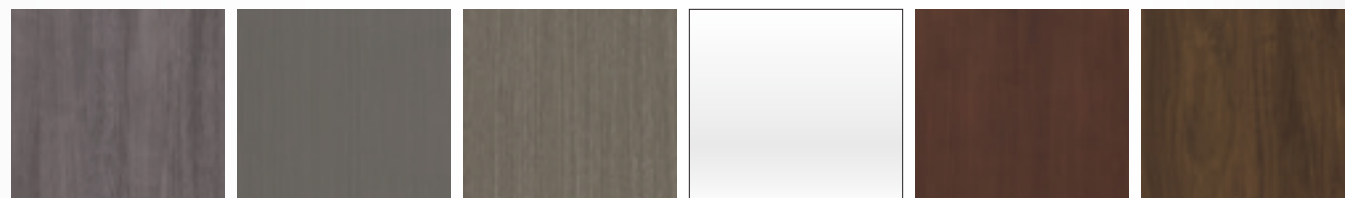

Sterling Ash Cosmic Strandz Boardwalk Oak Designer White Persian Cherry Mangalore Mango



Pinnacle Walnut Studio Teak Buka Bark Palisades Oak Natural Recon Mission Maple

# Colour Swatches

## 3mm Bonded Edges

Many more options available upon request. Please contact MityBilt for larger samples.

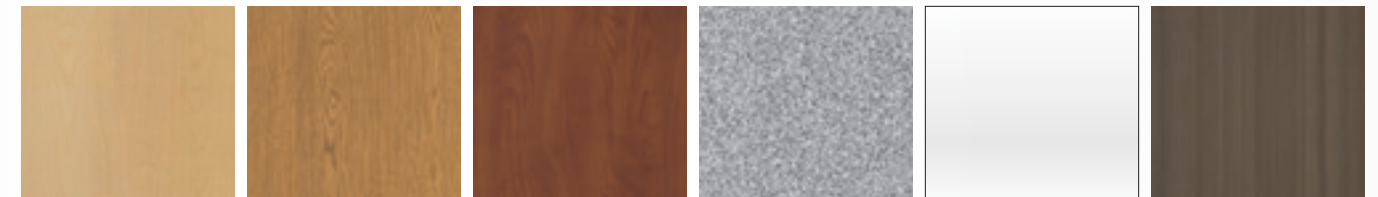

Fusion Maple Bannister Oak Wild Cherry Grey Nebula Designer White Studio Teak



Silver Charcoal Black Asian Night Cafelle

## Powder-Coat Options

Many more options available upon request. Please contact MityBilt for larger samples.



Silver Charcoal Black White Ivory



Gold Vein Copper Vein Silver Vein

## Suite 300

**Engineered to inspire.** The clean white finish of Suite 300 perfectly compliments the featured drawer fronts and modesty creating a distinct contemporary collection and a benchmark for intelligent clean design. The sophisticated styling of the leg and top surface imparts a clean modern design aesthetic that will effortlessly complement any corporate interior.



### Specifications

#### Construction

- 1" Industrial Grade Particleboard Core (45lbs foot density)
- High Pressure (HPL) scratch resistant laminate for longevity with balancing backer sheet
- 3mm vinyl bonded edge
- White 3/4" particle board carcass
- Colour featured drawer and door fronts
- Metal grommets

#### Colours & Finishes

- White powder coated frame
- Durable powdercoat finish from MityBilt colour selection
- High Pressure Laminate and 3mm vinyl bonded edge from MityBilt colour selection

#### Assembly

- All metal to metal hardware for strength and quick, simple assembly

#### Options

- Half or full height modesty
- Glass doors and keyboard corner

#### Configurations

- See page 59

### Suite 300 / Feature Colours

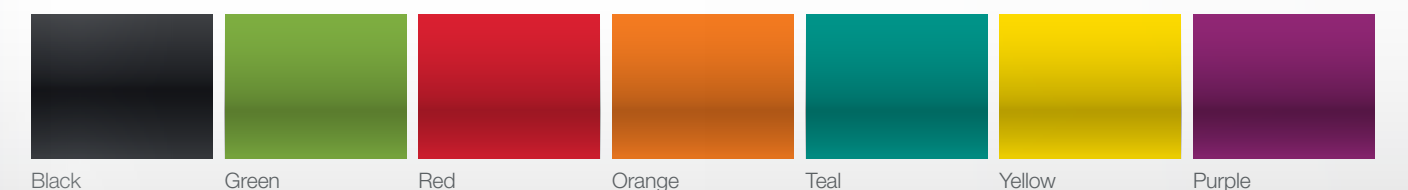

Black

Green

Red

Orange

Teal

Yellow

Purple

# Suite 200

**Designed to respond.** Workplace furniture that combines clean, classic lines with the natural beauty of wood always makes a professional impression and never goes out of style. That's why modular, versatile Suite 200 represents enduring value. Suite 200 allows you to transition with ease from private office to collaborative space, from traditional executive to minimal contemporary.



## Specifications

### Construction

- 1" Industrial Grade Particleboard Core (45lbs foot density)
- High Pressure (HPL) scratch resistant laminate for longevity with balancing backer sheet
- 3mm vinyl bonded edge
- White 3/4" particle board carcass
- Metal grommets
- Metal handles

### Colours & Finishes

- White powder coated frame
- Durable powdercoat finish from MityBilt colour selection
- High Pressure Laminate and 3mm vinyl bonded edge from MityBilt colour selection

### Assembly

- All metal to metal hardware for strength and quick, simple assembly

### Options

- Half or full height modesty
- Keyboard corner

## Suite 200 / Feature Colours

### High Pressure Work Surface Options

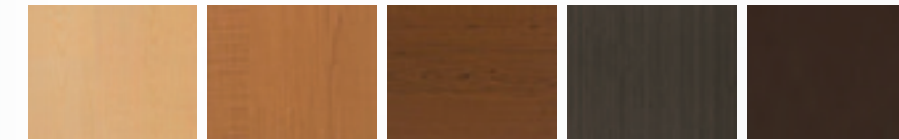

Maple

Amber

Smoky

Asian Night

Cafelle

### Carcass Options

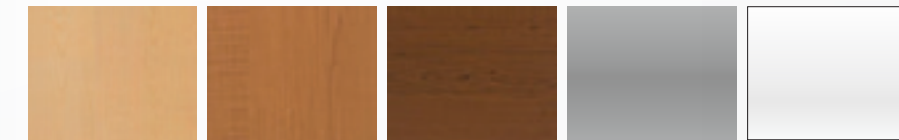

Maple

Amber

Smoky

Grey

White

### Frame Options



Black

Charcoal

Silver

White

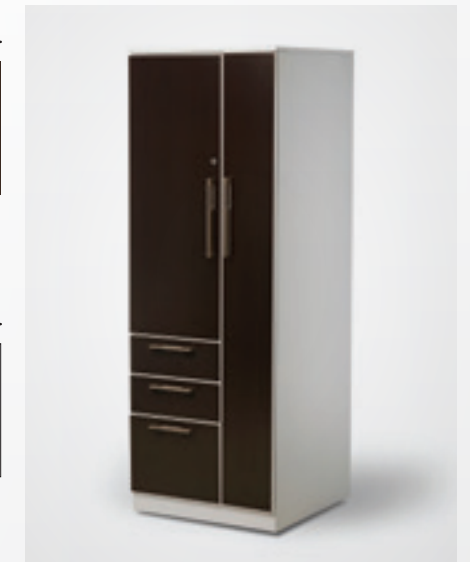

## Suite 200 / Configurations

### Desk



### + Full Return



### + Extended Return



### Desk + Hutch



### + Full Return



### + Extended Return



### Desk + Hutch + Wardrobe



### + Full Return



### + Extended Return



# Suite 100

**Built to outlive.** Suite 100 reflects the culture and creates the platform to enrich productivity. It has the ability to create an environment tailored to your specific needs. SUITE 100 is functional and compatible to it's user's needs in every office every day and is easy to specify, install and use.



## Specifications

### Construction

- 1" Industrial Grade Particleboard Core (45lbs foot density)
- Thermally fused dual laminated board
- Matching 3mm vinyl bonded edge

### Colours & Finishes

- White powder coated frame
- Durable powdercoat finish from MityBilt colour selection
- High Pressure Laminate and 3mm vinyl bonded edge from MityBilt colour selection

### Assembly

- All metal to metal hardware for strength and quick, simple assembly

### Options

- Half or full height modesty
- Keyboard corner

## Suite 100 / Feature Colours

### Work Surface & Carcass Options



Maple

Amber

Smoky

# Configurations

**Suite 100, 200, 300** / Configurations / Available in left or right hand options



Desk



Desk + Return



Desk + Return + Bridge



+ Pedestal



Desk + Return + Pedestal



Desk + Return + Pedestal + Bridge



+ Hutch



Desk + Return + Hutch



Desk + Return + Hutch + Bridge



+ Wardrobe



Desk + Return + Wardrobe



Desk + Return + Wardrobe + Bridge

Distributed in your area by:



# office

2015 / 2016 Products

Made in Canada by  
MityBilt Products Inc.

PO Box 1158, 20 Limestone Bay  
Stonewall, MB R0C 2Z0

TF. 866.282.7243 F. 204.467.5887

[www.MityBilt.com](http://www.MityBilt.com)



Limited Lifetime Warranty



Made in Canada

---

**MITY** BILT